



Chișinău Botanica str. Dimineții

104 900 €

67 m²

2

15/18

2



Moscovscaia Liubovi

Agent imobiliar

+37369772084





Informații

ID	12052
Suprafață totală	67m ²
Nivelul	15
Număr de nivele	18
Balcon	1 balcon
Fond locativ	Cladire nouă
Tipul clădirii	Cărămidă
Starea apartamentului	La alb
Seria	Individuală
Living	Apartament cu living



Moscovscaia Liubovi

Agent imobiliar

+37369772084  



Avantajele



Încălzire autonomă



Geamuri termopan



Pardosea caldă



Geamuri panoramice



Ușă blindată



Ascensor



Teren de joacă



Moscovscaia Liubovi

Agent imobiliar

+37369772084  



Descriere

TOATE OFERTELE DISPONIBILE LE GĂSIȚI

AICI www.topestate.md Vă propunem

apartament cu suprafața de 67 m.p. situat

pe str. Dimineții

Compania de construcții SkyHouse

Divizarea imobilului: - 2

dormitoare - Bucătărie - Bloc sanitar separat -

Balcon - Antreu

Dotări și avantaje: - Variantă

albă - Geamuri termopan - Încălzire

autonomă - Ușă blindată - Ascensor - Teren

de joacă - Parcare deschisă - Curte de tip

închisă

În imediată apropiere: - Magazin -

Farmacie - Grădiniță - Școală

Acces facil la

transportul public în orice direcție a

orașului. Comision 0% pentru

cumpărător!

Compania TOP ESTATE vă ajută

în procesul de vânzare- cumpărare a unui

imobil, teren sau spațiu comercial,

beneficiind de consultanță juridică în

domeniul imobiliar și accesarea unui credit

ipotecar.



Moscovscaia Liubovi

Agent imobiliar

+37369772084  



Chişinău Botanica str. Dimineţii

104 900 €

67 m²

2

15/18

2



Moscovscaia Liubovi

Agent imobiliar

+37369772084

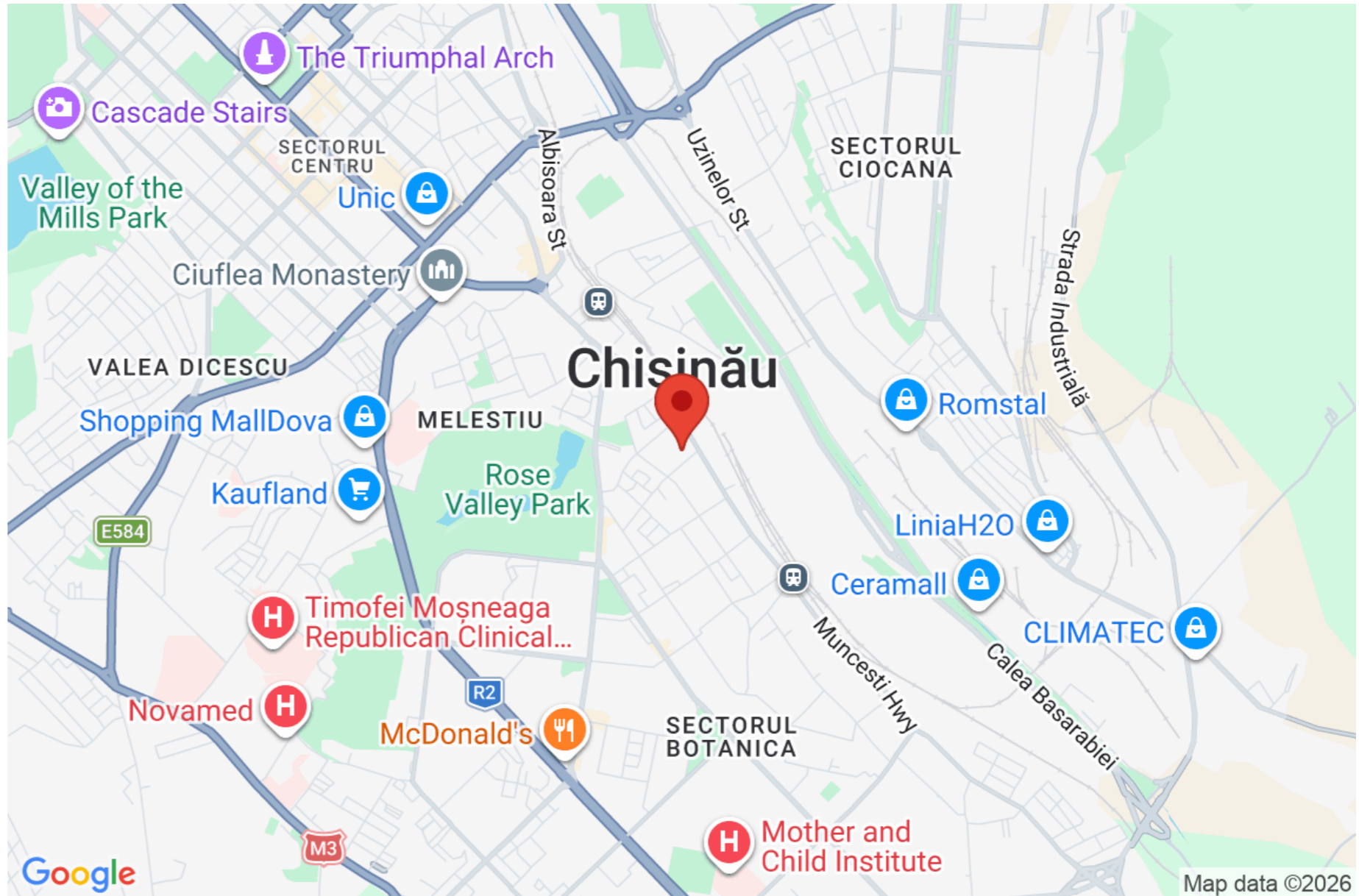



















Schema amplasarii
blocurilor

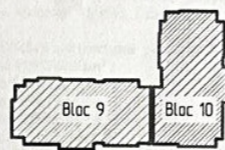

Schema amplasarii
apartamentului la etaj

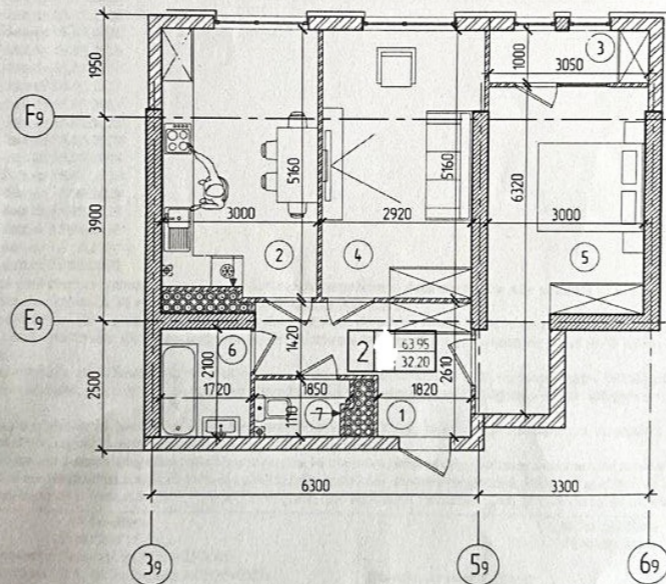
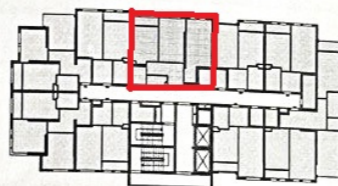

Nr.	Explicatie	S. m ²
1	Antreu-Hall	8.10
2	Bucatarie	15.10
3	Veranda	3.05
4	Salon	15.90
5	Dormitor	16.30
6	Baie	3.60
7	WC	1.90

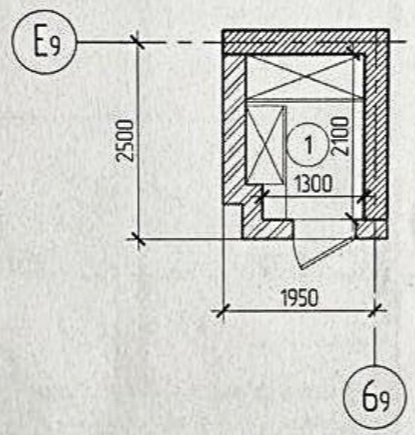

Nr.	Explicatie	S. m ²
1	Debara	300

